

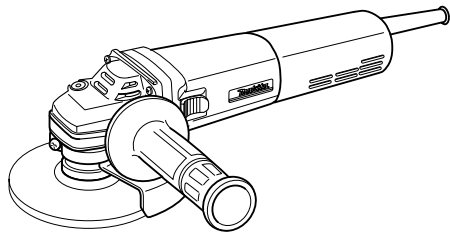

# Angle Grinder

MODEL 9564

MODEL 9565



004266



## I N S T R U C T I O N M A N U A L

**⚠ WARNING:**

For your personal safety, READ and UNDERSTAND before using.  
SAVE THESE INSTRUCTIONS FOR FUTURE REFERENCE.

---

# SPECIFICATIONS

Model	9564	9565
Wheel diameter	115 mm (4-1/2")	125 mm (5")
Spindle thread	5/8"	5/8"
No load speed (RPM)	10,500/min	10,500/min
Overall length	299 mm (11-3/4")	299 mm (11-3/4")
Net weight	1.8 kg (4.0 lbs)	1.8 kg (4.0 lbs)

- Manufacturer reserves the right to change specifications without notice.
- Specifications may differ from country to country.

---

# GENERAL SAFETY RULES

USA002-2

(For All Tools)

## **⚠ WARNING:**

**Read and understand all instructions.** Failure to follow all instructions listed below, may result in electric shock, fire and/or serious personal injury.

---

# SAVE THESE INSTRUCTIONS

## Work Area

1. **Keep your work area clean and well lit.** Cluttered benches and dark areas invite accidents.
2. **Do not operate power tools in explosive atmospheres, such as in the presence of flammable liquids, gases, or dust.** Power tools create sparks which may ignite the dust or fumes.
3. **Keep bystanders, children, and visitors away while operating a power tool.** Distractions can cause you to lose control.

## Electrical Safety

4. **Double insulated tools are equipped with a polarized plug (one blade is wider than the other.) This plug will fit in a polarized outlet only one way. If the plug does not fit fully in the outlet, reverse the plug. If it still does not fit, contact a qualified electrician to install a polarized outlet. Do not change the plug in any way.** Double insulation  eliminates the need for the three wire grounded power cord and grounded power supply system.

- 
5. **Avoid body contact with grounded surfaces such as pipes, radiators, ranges and refrigerators.** There is an increased risk of electric shock if your body is grounded.
  6. **Do not expose power tools to rain or wet conditions.** Water entering a power tool will increase the risk of electric shock.
  7. **Do not abuse the cord. Never use the cord to carry the tools or pull the plug from an outlet. Keep cord away from heat, oil, sharp edges or moving parts. Replace damaged cords immediately.** Damaged cords increase the risk of electric shock.
  8. **When operating a power tool outside, use an outdoor extension cord marked “W-A” or “W”.** These cords are rated for outdoor use and reduce the risk of electric shock.

## Personal Safety

9. **Stay alert, watch what you are doing and use common sense when operating a power tool. Do not use tool while tired or under the influence of drugs, alcohol, or medication.** A moment of inattention while operating power tools may result in serious personal injury.
10. **Dress properly. Do not wear loose clothing or jewelry. Contain long hair. Keep your hair, clothing, and gloves away from moving parts.** Loose clothes, jewelry, or long hair can be caught in moving parts.
11. **Avoid accidental starting. Be sure switch is off before plugging in.** Carrying tools with your finger on the switch or plugging in tools that have the switch on invites accidents.
12. **Remove adjusting keys or wrenches before turning the tool on.** A wrench or a key that is left attached to a rotating part of the tool may result in personal injury.
13. **Do not overreach. Keep proper footing and balance at all times.** Proper footing and balance enables better control of the tool in unexpected situations.
14. **Use safety equipment. Always wear eye protection.** Dust mask, non-skid safety shoes, hard hat, or hearing protection must

be used for appropriate conditions. Ordinary eye or sun glasses are NOT eye protection.

## Tool Use and Care

15. **Use clamps or other practical way to secure and support the workpiece to a stable platform.** Holding the work by hand or against your body is unstable and may lead to loss of control.
16. **Do not force tool. Use the correct tool for your application.** The correct tool will do the job better and safer at the rate for which it is designed.
17. **Do not use tool if switch does not turn it on or off.** Any tool that cannot be controlled with the switch is dangerous and must be repaired.
18. **Disconnect the plug from the power source before making any adjustments, changing accessories, or storing the tool.** Such preventive safety measures reduce the risk of starting the tool accidentally.
19. **Store idle tools out of reach of children and other untrained persons.** Tools are dangerous in the hands of untrained users.
20. **Maintain tools with care. Keep cutting tools sharp and clean.** Properly maintained tools with sharp cutting edges are less likely to bind and are easier to control.
21. **Check for misalignment or binding of moving parts, breakage of parts, and any other condition that may affect the tools operation. If damaged, have the tool serviced before using.** Many accidents are caused by poorly maintained tools.
22. **Use only accessories that are recommended by the manufacturer for your model.** Accessories that may be suitable for one tool, may become hazardous when used on another tool.

## SERVICE

23. **Tool service must be performed only by qualified repair personnel.** Service or maintenance performed by unqualified personnel could result in a risk of injury.

**24. When servicing a tool, use only identical replacement parts. Follow instructions in the Maintenance section of this manual.**

Use of unauthorized parts or failure to follow Maintenance instructions may create a risk of electric shock or injury.

**USE PROPER EXTENSION CORD:** Make sure your extension cord is in good condition. When using an extension cord, be sure to use one heavy enough to carry the current your product will draw. An undersized cord will cause a drop in line voltage resulting in loss of power and overheating. Table 1 shows the correct size to use depending on cord length and nameplate ampere rating. If in doubt, use the next heavier gage. The smaller the gage number, the heavier the cord.

**Table 1: Minimum gage for cord**

Ampere Rating		Volts	Total length of cord in feet			
		120 V	25 ft.	50 ft.	100 ft.	150 ft.
More Than	Not More Than	AWG				
0	6		18	16	16	14
6	10		18	16	14	12
10	12		16	16	14	12
12	16		14	12	Not Recommended	

## SPECIFIC SAFETY RULES

USB005-3

**DO NOT let comfort or familiarity with product (gained from repeated use) replace strict adherence to grinder safety rules. If you use this tool unsafely or incorrectly, you can suffer serious personal injury.**

- Always use proper guard with grinding wheel.** A guard protects operator from broken wheel fragments.
- Accessories must be rated for at least the speed recommended on the tool warning label.** Wheels and other accessories running over rated speed can fly apart and cause injury.
- Hold tool by insulated gripping surfaces when performing an operation where the cutting tool may contact hidden wiring or its own cord.** Contact with a “live” wire will make exposed metal parts of the tool “live” and shock the operator.
- When using depressed center grinding wheels, be sure to use only fiberglass-reinforced wheels.**
- Always use safety glasses or goggles.** Ordinary eye or sun glasses are NOT safety glasses.
- Check the wheel carefully for cracks or damage before operation.** Replace cracked or damaged wheel immediately. Run the tool (with guard) at no load for about a minute, holding tool away from others. If wheel is flawed, it will likely separate during this test.
- Use only flanges specified for this tool.**

- 
8. Be careful not to damage the spindle, the flange (especially the installing surface) or the lock nut. Damage to these parts could result in wheel breakage.
  9. NEVER use tool with wood cutting blades or other sawblades. Such blades when used on a grinder frequently kick and cause loss of control leading to personal injury.
  10. Hold the tool firmly.
  11. Keep hands away from rotating parts.
  12. Make sure cord is clear of wheel. Do not wrap cord around your arm or wrist. If control of tool is lost, cord may become wrapped around you and cause personal injury.
  13. Make sure the wheel is not contacting the workpiece before the switch is turned on.
  14. Before using the tool on an actual workpiece, let it run for a while. Watch for vibration or wobbling that could indicate poor installation or a poorly balanced wheel.
  15. Use the specified surface of the wheel to perform the grinding.
  16. Watch out for flying sparks. Hold the tool so that sparks fly away from you and other persons or flammable materials.
  17. Do not leave the tool running. Operate the tool only when hand-held.
  18. Do not touch the workpiece immediately after operation; it may be extremely hot and could burn your skin.
  19. ALWAYS wear proper apparel including long sleeve shirts, leather gloves and shop aprons to protect skin from contact with hot grindings.
  20. Use of this tool to grind or sand some products, paints and wood could expose user to dust containing hazardous substances. Use appropriate respiratory protection.

---

## SAVE THESE INSTRUCTIONS

**⚠ WARNING:**  
**MISUSE or failure to follow the safety rules stated in this instruction manual may cause serious personal injury.**

---

## SYMBOLS

USD201-1

The followings show the symbols used for tool.

- |  |                     |                   |   |
|--|---------------------|-------------------|---|
| V .....  | volts               | ∅ .....           | no load speed                           |
| A .....  | amperes             | ☐ .....           | Class II Construction                   |
| Hz .....   | hertz               | .../min or RPM... | revolutions or reciprocation per minute |
|  ..... | alternating current |                   |   |

## FUNCTIONAL DESCRIPTION

### ⚠ CAUTION:

- Always be sure that the tool is switched off and unplugged before adjusting or checking function on the tool.

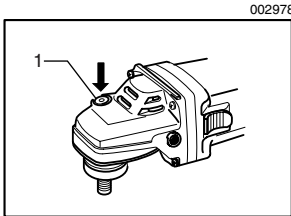

1. Shaft lock

### Shaft lock

### ⚠ CAUTION:

- Never actuate the shaft lock when the spindle is moving. The tool may be damaged.

Press the shaft lock to prevent spindle rotation when installing or removing accessories.

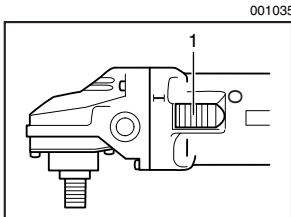

1. Slide switch

### Switch action

### ⚠ CAUTION:

- Before plugging in the tool, always check to see that the slide switch actuates properly and returns to the “OFF” position when the rear of the slide switch is depressed.
- Switch can be locked in “ON” position for ease of operator comfort during extended use. Apply caution when locking tool in “ON” position and maintain firm grasp on tool.

To start the tool, slide the slide switch toward the “I (ON)” position. For continuous operation, press the front of the slide switch to lock it.

To stop the tool, press the rear of the slide switch, then slide it toward the “O (OFF)” position.

## ASSEMBLY

### ⚠ CAUTION:

- Always be sure that the tool is switched off and unplugged before carrying out any work on the tool.

002979

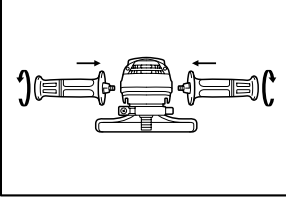

## Installing side grip (handle)

### ⚠ CAUTION:

- Always be sure that the side grip is installed securely before operation.

Screw the side grip securely on the position of the tool as shown in the figure.

005589

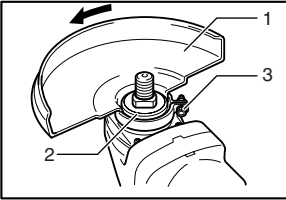

1. Wheel guard
2. Bearing box
3. Screw

## Installing or removing wheel guard

### ⚠ CAUTION:

- When using a depressed center grinding wheel/Multi-disc, wire wheel brush or cut-off wheel, the wheel guard must be fitted on the tool so that the closed side of the guard always points toward the operator.

Mount the wheel guard with the protrusion on the wheel guard band aligned with the notch on the bearing box. Then rotate the wheel guard around 180 degrees. Be sure to tighten the screw securely.

To remove wheel guard, follow the installation procedure in reverse.

001071

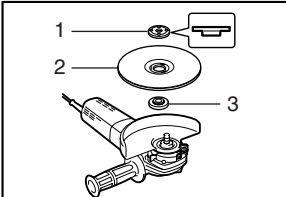

1. Lock nut
2. Depressed center grinding wheel/  
Multi-disc
3. Inner flange

## Installing or removing depressed center grinding wheel/Multi-disc

### ⚠ WARNING:

- Always use supplied guard when depressed center grinding wheel/Multi-disc is on tool. Wheel can shatter during use and guard helps to reduce chances of personal injury.

Mount the inner flange onto the spindle. Fit the wheel/disc on the inner flange and screw the lock nut onto the spindle.

To tighten the lock nut, press the shaft lock firmly so that the spindle cannot revolve, then use the lock nut wrench and securely tighten clockwise.

To remove the wheel, follow the installation procedure in reverse.

001084

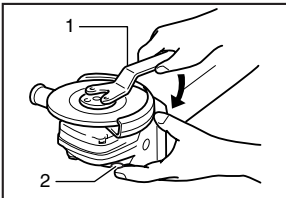

1. Lock nut wrench
2. Shaft lock

001107

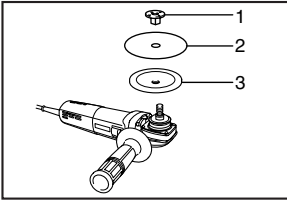

1. Lock nut
2. Abrasive disc
3. Rubber pad

## Installing or removing abrasive disc (optional accessory)

### NOTE:

- Use sander accessories specified in this manual. These must be purchased separately.

Mount the rubber pad onto the spindle. Fit the disc on the rubber pad and screw the lock nut onto the spindle. To tighten the lock nut, press the shaft lock firmly so that the spindle cannot revolve, then use the lock nut wrench and securely tighten clockwise.

To remove the disc, follow the installation procedure in reverse.

## OPERATION

### ⚠ WARNING:

- It should never be necessary to force the tool. The weight of the tool applies adequate pressure. Forcing and excessive pressure could cause dangerous wheel breakage.
- ALWAYS replace wheel if tool is dropped while grinding.
- NEVER bang or hit grinding disc or wheel onto work.
- Avoid bouncing and snagging the wheel, especially when working corners, sharp edges etc. This can cause loss of control and kickback.
- NEVER use tool with wood cutting blades and other sawblades. Such blades when used on a grinder frequently kick and cause loss of control leading to personal injury.

### ⚠ CAUTION:

- After operation, always switch off the tool and wait until the wheel has come to a complete stop before putting the tool down.



002983

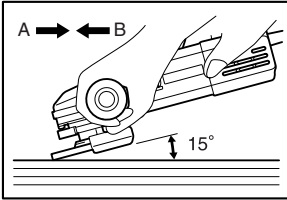

## Grinding and sanding operation

ALWAYS hold the tool firmly with one hand on housing and the other on the side handle. Turn the tool on and then apply the wheel or disc to the workpiece.

In general, keep the edge of the wheel or disc at an angle of about 15 degrees to the workpiece surface.

During the break-in period with a new wheel, do not work the grinder in the B direction or it will cut into the workpiece. Once the edge of the wheel has been rounded off by use, the wheel may be worked in both A and B direction.

001136

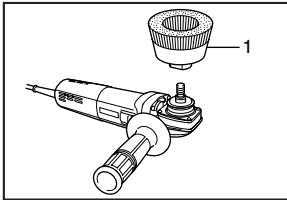

1. Wire cup brush

## Operation with wire cup brush (optional accessory)

### ⚠ CAUTION:

- Check operation of brush by running tool with no load, insuring that no one is in front of or in line with brush.
- Do not use brush that is damaged, or which is out of balance. Use of damaged brush could increase potential for injury from contact with broken brush wires.

Unplug tool and place it upside down allowing easy access to spindle. Remove any accessories on spindle. Thread wire cup brush onto spindle and tighten with supplied wrench. When using brush, avoid applying too much pressure which causes over bending of wires, leading to premature breakage.

001229

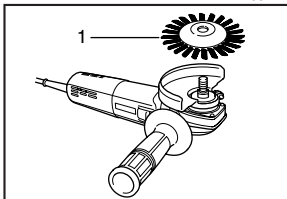

1. Wire wheel brush

## Operation with wire wheel brush (optional accessory)

### ⚠ CAUTION:

- Check operation of wire wheel brush by running tool with no load, insuring that no one is in front of or in line with the wire wheel brush.
- Do not use wire wheel brush that is damaged, or which is out of balance. Use of damaged wire wheel brush could increase potential for injury from contact with broken wires.
- ALWAYS use guard with wire wheel brushes, assuring diameter of wheel fits inside guard. Wheel can shatter during use and guard helps to reduce chances of personal injury.

Unplug tool and place it upside down allowing easy access to spindle. Remove any accessories on spindle. Thread wire wheel brush onto spindle and tighten with the wrenches. When using wire wheel brush, avoid applying too much pressure which causes over bending of wires, leading to premature breakage.

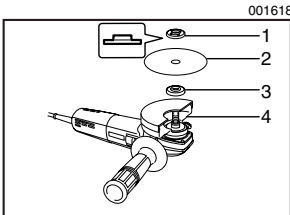

1. Lock nut
2. Abrasive cut-off wheel
3. Inner flange
4. Wheel guard for cut-off wheel

## Operation with abrasive cut-off wheel (optional accessory)

### ⚠ WARNING:

- When using an abrasive cut-off wheel, be sure to use only the special wheel guard designed for use with cut-off wheels.
- NEVER use cut-off wheel for side grinding.

During cutting operations, never change the angle of the wheel. Placing side pressure on the cut-off wheel (as in grinding) will cause the wheel to crack and break, causing serious personal injury.

## MAINTENANCE

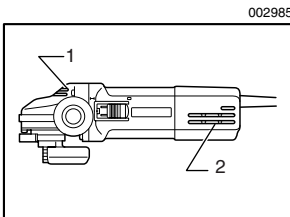

1. Exhaust vent
2. Inhalation vent

### ⚠ CAUTION:

- Always be sure that the tool is switched off and unplugged before attempting to perform inspection or maintenance.

The tool and its air vents have to be kept clean. Regularly clean the tool's air vents or whenever the vents start to become obstructed.

To maintain product SAFETY and RELIABILITY, repairs, carbon brush inspection and replacement, any other maintenance or adjustment should be performed by Makita Authorized or Factory Service Centers, always using Makita replacement parts.

## ACCESSORIES

### ⚠ CAUTION:

- These accessories or attachments are recommended for use with your Makita tool specified in this manual. The use of any other accessories or attachments might present a risk of injury to persons. Only use accessory or attachment for its stated purpose.

- Your tool is supplied with a guard for use with a depressed center grinding wheel, multi-disc and wire wheel brush. A cut-off wheel can also be used with an optional guard. If you decide to use your Makita grinder with approved accessories which you purchase from your Makita distributor or factory service center, be sure to obtain and use all necessary fasteners and guards as recommended in this manual. Your failure to do so could result in personal injury to you and others.

If you need any assistance for more details regarding these accessories, ask your local Makita service center.

005514

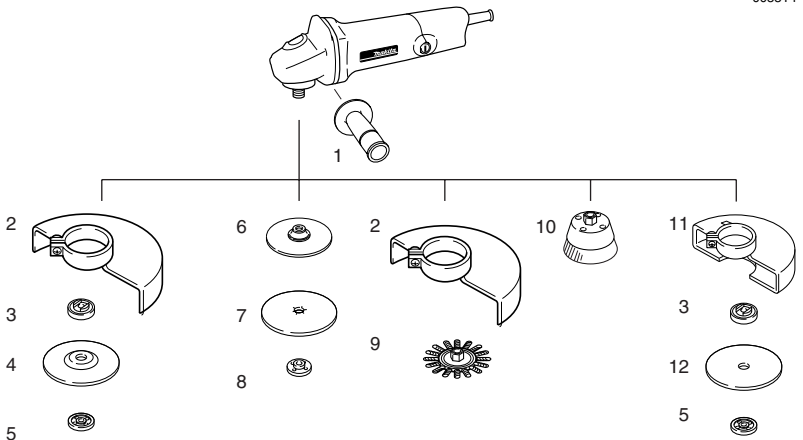

C00162

	9564	9565
1	Grip 36	
2	Wheel guard	
3	Inner flange 45	
4	Depressed center grinding wheel/Multi-disc	
5	Lock nut 5/8-45	
6	Rubber pad 100	Rubber pad 115
7	Abrasive disc	
8	Sanding lock nut 5/8-48	
9	Wire wheel brush	
10	Wire cup brush	
11	Wheel guard (For cut-off wheel)	
12	Cut-off wheel	
-	Lock nut wrench 28	



Cut



**Makita Canada Inc.  
1950 Forbes Street,  
Whitby, Ontario  
L1N 7B7**

Stamp  
Timbre

Fold



# Factory Service Centres

<b>Head Office:</b>	1950 Forbes St., Whitby, Ontario, L1N 7B7 (905) 571 - 2200	1-800-263-3734
<b>Regional Office:</b>	11771 Hammersmith Way, Richmond B.C. V7A 5H6 (604) 272 - 3104	1-800-663-0909
<b>Regional Office:</b> (Montreal)	6389 boul. Couture, St. Leonard, Quebec H1P 3J5 (514) 323 - 1223	1-800-361-7049
<b>Dartmouth:</b>	202 Brownlow Avenue Dartmouth, N.S., B3B 1T5 (902) 468 - 7064	1-888-625-4821
<b>Ville St. Laurent:</b> (Montreal)	1140 Rue Bégin, Ville St. Laurent, Quebec H4R 1X1 (514) 745 - 5025	1-888-745-5025
<b>Les Saules:</b> (Quebec)	1200 St. Jean Baptiste, Unit 106, Les Saules, Quebec, G2E 5E8 (418) 871 - 5720	1-800-663-5757
<b>Nepean:</b> (Ottawa)	210 Colonnade Road, Unit 11, Nepean, Ontario, K2E 7M1 (613) 224 - 5022	1-888-560-2214
<b>Whitby:</b>	1950 Forbes St., Whitby, Ontario, L1N 7B7 (905) 571 - 2200	1-800-263-3734
<b>London:</b>	317 Adelaide St. S., Unit 117, London, Ontario, N5Z 3L3 (519) 686 - 3115	1-800-571-0899
<b>Mississauga:</b>	6350 Tomken Rd., Unit 8, Mississauga, Ontario, L5T 1Y3 (905) 670 - 7255	1-888-221-9811
<b>Calgary:</b>	#8-6115 Fourth St. S.E., Calgary Alberta, T2H 2H9 (403) 243 - 3995	1-800-267-0445
<b>Edmonton:</b>	11614-149 Street, Edmonton, Alberta, T5M 3R3 (780) 455 - 6644	1-888-455-6644
<b>Richmond:</b>	11771 Hammersmith Way, Richmond, B.C., V7A 5H6 (604) 272 - 3104	1-800-663-0909
<b>Coquitlam:</b>	2131 Hartley Ave., #103 Coquitlam, B.C. V3K 2Z3 (604) 525 - 7434	1-800-266-7738
<b>Winnipeg:</b>	1670 St. James Street, Winnipeg, Manitoba, R3H 0L3 (204) 694 - 0402	1-800-550-5073
<b>Saskatoon:</b>	206A-2750 Faithful Avenue Saskatoon, Saskatchewan, S7K 6M6 (306) 931 - 0111	1-888-931-0111

For the authorized service centre nearest you please refer to the local yellow pages directory under "tools" or contact our customer service department (Tel) 1-800-263-3734

## When you need service...

- Explain the problem in a letter
- Enclose the letter with the tool
- Package carefully and send prepaid to the nearest Makita factory or authorized service centre

## CUSTOMER RECORD

DATE  
 PURCHASED: \_\_\_\_\_  
 DEALER'S NAME  
 & ADDRESS: \_\_\_\_\_  
 \_\_\_\_\_  
 MODEL NO.: \_\_\_\_\_  
 SERIAL NO.: \_\_\_\_\_

# MAKITA LIMITED ONE YEAR WARRANTY

## Warranty Policy

Every Makita tool is thoroughly inspected and tested before leaving the factory. It is warranted to be free of defects from workmanship and materials for the period of ONE YEAR from the date of original purchase. Should any trouble develop during this one year period, return the COMPLETE tool, freight prepaid, to one of Makita's Factory or Authorized Service Centres. If inspection shows the trouble is caused by defective workmanship or material, Makita will repair (or at our option, replace) without charge.

This Warranty does not apply:

- where normal maintenance is required,
- repairs have been made or attempted by others,
- the tool has been abused, misused or improperly maintained,
- alterations have been made to the tool.

IN NO EVENT SHALL MAKITA BE LIABLE FOR ANY INDIRECT, INCIDENTAL OR CONSEQUENTIAL DAMAGES FROM THE SALE OR USE OF THE PRODUCT. THIS DISCLAIMER APPLIES BOTH DURING AND AFTER THE TERM OF THIS WARRANTY.

"The Makita Warranty is the only and the entire written warranty given by Makita for the Makita tools. No dealer or his agent or employee is authorized to extend or enlarge upon this warranty by any verbal or written statement or advertisement."

MAKITA DISCLAIMS LIABILITY FOR ANY IMPLIED WARRANTIES INCLUDING IMPLIED WARRANTIES OF "MERCHANTABILITY" AND FITNESS FOR A SPECIFIC PURPOSE," AFTER THE ONE YEAR TERM OF THIS WARRANTY.

"This Warranty gives you specific rights. The provisions contained in this warranty are not intended to limit, modify, take away from, disclaim or exclude any warranties set forth in any provincial legislation. To the extent required by law, the provisions in any provincial or federal legislation with respect to warranties take precedence over the provisions in this warranty."

**Makita Corporation**  
3-11-8, Sumiyoshi-cho,  
Anjo, Aichi 446-8502 Japan